



## Application of modern information technologies on the design and simulation of mediterranean greenhouses, an experience

Bienvenido J.F., Diaz Alvarez J.R., Ayala R., Becerra A., Bosch A., Garcia J.R., Guirado R., Iribarne L., Rodríguez F., Tùnez S., Casado A., Corral A.

*in*

Choukr-Allah R. (ed.).  
Protected cultivation in the Mediterranean region

Paris : CIHEAM / IAV Hassan II  
Cahiers Options Méditerranéennes; n. 31

1999  
pages 45-57

Article available on line / Article disponible en ligne à l'adresse :

<http://om.ciheam.org/article.php?IDPDF=C1020830>

To cite this article / Pour citer cet article

Bienvenido J.F., Diaz Alvarez J.R., Ayala R., Becerra A., Bosch A., Garcia J.R., Guirado R., Iribarne L., Rodríguez F., Tùnez S., Casado A., Corral A. **Application of modern information technologies on the design and simulation of mediterranean greenhouses, an experience.** In : Choukr-Allah R. (ed.). *Protected cultivation in the Mediterranean region* . Paris : CIHEAM / IAV Hassan II, 1999. p. 45-57 (Cahiers Options Méditerranéennes; n. 31)



<http://www.ciheam.org/>  
<http://om.ciheam.org/>



# APPLICATION OF MODERN INFORMATION TECHNOLOGIES ON THE DESIGN AND SIMULATION ON MEDITERRANEAN GREENHOUSES, AN EXPERIENCE

J.F.BIENVENIDO<sup>1</sup>, J.R. DIAZ<sup>2</sup>, R-AYALA<sup>1</sup>, A.BECERRA<sup>1</sup>, A-BOSCH<sup>1</sup>, J. R.  
GARCIA<sup>1</sup>, R.GUIRADO<sup>1</sup>, L. IRIBARNE<sup>1</sup>, F. RODRIGUEZ<sup>1</sup>, S. TÙNEZ<sup>1</sup>, A.  
CASADO<sup>3</sup>, A. CORRAL<sup>3</sup>

<sup>1</sup> Dpts. of Computer Science (DLC) and <sup>2</sup> Agrarian Economy (DFSPA)  
University of Almeria. E-04120 Almeria (Spain).

<sup>3</sup> Fundación para la Investigación Agraria en la Provincia de Almeria (FIAPA).  
Crta. de la Playa s/n E-04120 Almeria (Spain).

**Abstract:** The liberalization of the markets forces the renovation and technification of the greenhouse structures in our region. The main objective of this project was the computer aided design of customized, controlled greenhouses and the development of marketable prototypes. A general design and simulation tool has been built applying advanced information technologies (declarative descriptions, multiagent architectures, finite elements processing,...). Between the results is the INAMED greenhouse, marketed by two distributors, which offers a better microclimatic performance. We have developed a design tool, which can be used by the agronomic technicians for generating complete greenhouse projects (including their plans and budgets). There are other indirect results oriented to the development of other greenhouse typologies and the enhance of their knowledge. We present some possible further developments.

## INTRODUCTION

In order to maintain and improve the development reached in the mediterranean mild winter regions, the markets liberalization demands a better product quality and harvest opportunity on the greenhouse crop growing.

At present, we can differentiate two great approaches to the crop growing in greenhouses:

- High-cost greenhouses of high yield and active microclimatic conditioning (North and Central Europe).
- Low-cost greenhouses of medium yield, normally passive, taking advantage of favorable outside climatic condition (Mediterranean region, including Almeria).

In our case, the quality and opportunity improvements required can be achieved enhancing the microclimatic conditions of our greenhouses, via the development of new greenhouse structures with better possibilities of microclimatic conditioning. Our problem is the regulation of the microclimatic conditions, in a more passive way.

The most of the models of greenhouses, activity in use in our area, have been developed empirically by our farmers. They are assembled on a handcraft basis. The use of industrial design and simulation techniques can increase the performance of the greenhouses, and force the application of the EU and national normative. The use of standard parts and chain assembling techniques can reduce costs.

Among the efforts aimed at achieving this evolution figures the DAMOCIA project, financed by the E.U. in the framework of the ESPRIT Special Action P7510 PACE and the Spanish Ministry of Industry in the framework of the PATI PC 191.

## DAMOCIA PROJECT

The overall objective of our project is the computer aided design of customized, controlled greenhouses and the development of marketable prototypes. Generating, mainly, a set of marketable greenhouse prototypes related with the agronomic and economic optimums, and a design and modellization tool. In order to reach this general objective, the task was structured in five main basic working lines.

- a) Development of a model defining greenhouse characteristics on the basis of wanted priority agronomic use.
- b) Creation and use of a software tool that allows definition of the structure and quantification of the construction costs of the proposed greenhouse models, as well as elaboration of their construction projects.
- c) Development of a simulator that permits modellization of the behavior of the proposed structures, in a first stage with radiation interception.
- d) Implantation of an acquisition system to validate, in the field, the proposed models, including a bioclimatic control system.
- e) Construction of 3 or 4 different prototypes and the subsequent industrial and commercial development of these. We have built various greenhouse structures, the most standard type, other alternatives in expansion and other totally new ones.

Onto the development of the project, we have used these software tools:

- Design line : Autocad v12; Autolisp; Borland C++; Catia v4 release 1.2.
- Modellization line: Borland C++; Graphics Server; MatLab; Excel v5.0.
- Acquisition and control line: LabVIEW; Builder Applications; MatLab; Simulink; Toolbox of Control, Excel v5.0.
- Exploitation Fine: Borland C-@-+; Visual C-@+; Graphics Server; LabVIEW; Excel v5.0.

As hardware we have used diverse Unix Workstations and PCs, and an acquisition and control system based on National Instruments parts.

The design and simulation tools are linked onto a unique software set splitted on two main modules where we have used new computer software techniques, like

- Independent software agents.
- Declarative structures for agents' relation.
- Calling of agents from external tables references.
- Several declarative definition levels of the greenhouses or experiment descriptions.
- An independent user interface. Validation included.
- Standard and general-purpose systems.
- Discrete elements simulation technologies

## DESIGN TOOL

The Design module allows the definition of the structure and quantification of the construction costs of the proposed greenhouse models, as well as the elaboration of their construction projects. The tool includes these submodules: declarative definition of structures (with constraints-based user recommendations), automatic elaboration of plans in AutoCAD format (connecting our C program with AutoCad), budget preparation, and a structure behavior calculator. The following diagram shows the structures of this tool.

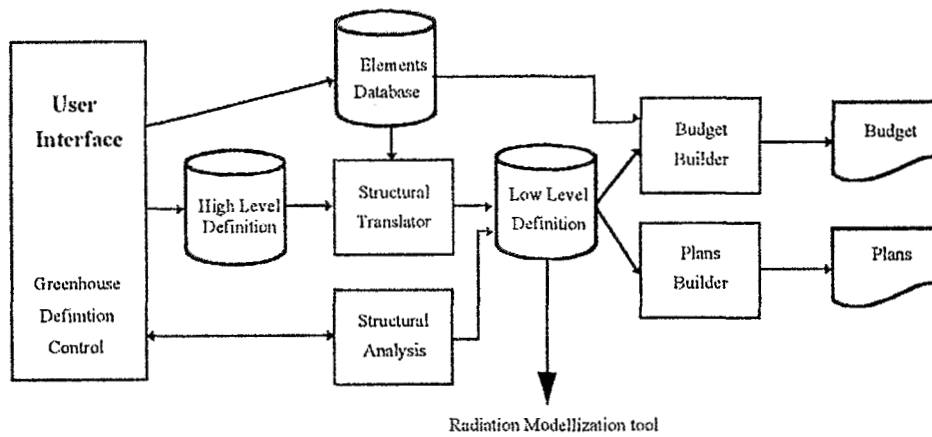

The tool uses different level declarative descriptions

- High level definition: the greenhouse is described in a compact format. It let an easy user interaction. The different constructive aspects (ground plant, structure, etc.) are described by templates, which can be used with different typologies. The high lever description has been formalized with a BNF grammar:

```

<High level def.> ::= <Ground plan> <Frame> <Piles> <Laying of foundations>
<Openings> <Wire mesh> <Plastic>
<Ground plan> ::= 1 0 <Length> <Length> <Orientation>
<Frame> ::= <Planar fr.> | <Asymmetric fr.> | <Symmetric fr.> | <Invernav fr.> | <Inamed fr.> |
<Asymmetric fr.> ::= 2 2 <Height> <Height> <Side> <N> <Side> <N> <N> <N> <N>
<Symmetric fr.> ::= 2 3 <Height> <Height> <Height> <Side> <N> <N> <N> <N> <N>
    
```

- Low level definition: The greenhouse is described by its most basic elements, which are taken from an element database. They incorporate the exact dimensions and space location of the parts. Their description with a BNF grammar is:

```

<Low level def.> ::= <Element> | <Low lever def.> <Element>
<Element> ::= <Ground perimeter> | <Greenhouse perimeter> | <Concrète band> |
<We> | <Path> |
<Concrete cube> | <Pile> | <Wire> | <Plastic fastening mesh> | <Opening> | <Door> |
<Window> | <Mosquito net> | <Plastic> | <Pipe> | <Demarcation> | <Ring> |
<Pipe fastening> | <Roller fastening>
<Ground perimeter> ::= <Poligonal perimeter parcel> | <Curved perimeter parcel>
<Greenhouse perimeter> ::= <Poligonal perim. greenh.> | <Curved perim. greenh.>
<Terrace perim. greenh.>
<Concrete band> ::= <Perim. concrete band> | <intermediate concrete band>
    
```

With the two level definition formula, we isolate the effects of adding new structure typologies onto the high level definition and the structural translator. Automatically, the design tool translates the high lever definition, and it uses the low level definition to generate the complete greenhouse projects:

- Plans in AUTOCAD format
- Budget
- Structural analysis

## MODELLIZATION TOOL

This module models the behavior of the radiation into the proposed structures. We have based the simulation on ideas by Bot (1983) and Critten (1988), applying new computer technologies. Next figure represents the general diagram of this tool.

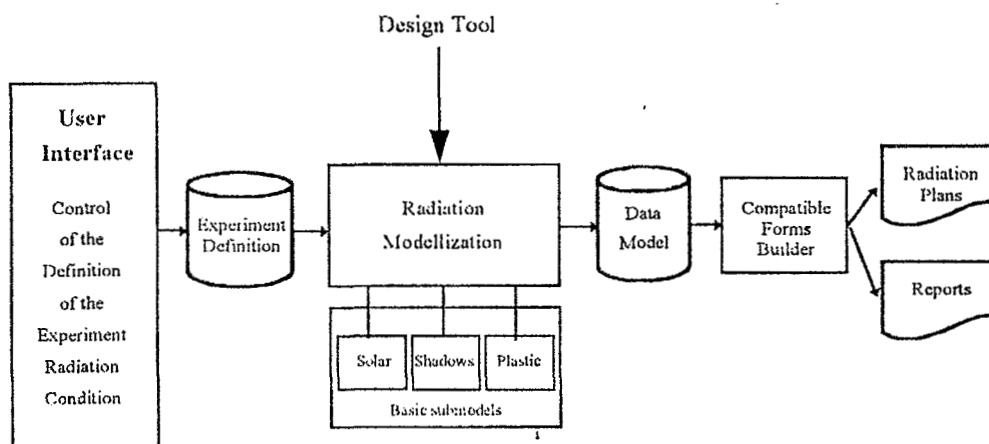

The radiation simulator uses as input the format definition of the greenhouse generated in the design module, and the desired simulation profile. The greenhouse description corresponds to a specific one, with concrete localization, dimensions, materials, and etceteras.

The tool divides the surfaces (defined in a general way into the space) on discrete elements that are computed as units of treatment. We have discretized, too, the time flow along the day onto the simulator.

We have developed the following mathematical models, used into the modeller:

- a) External radiation models. (Several) They compute the basic direct and diffuse radiation components over an horizontal surface. Also, they compute the direction components of the sunlight during the day.
- b) Plastic response models. (Several) They evaluate the rate of radiation absorbed by the cover. Depending on the cover material, an agent with a defined model is activated.
- c) Shading models. (Several) For each greenhouse surface, they compute the shading and illuminated areas generated by the other surfaces, using the sunlight direction.
- d) Internal radiation models. (Several) There are two submodels: by surfaces and volumetric. As example, the next figure shows the projection of each radiating element over the different internal horizontal surfaces.

This model generates radiation maps at different levels into an empty greenhouse.

- e) Canopy effect model. (In development). Using a volumetric model of the internal radiation, it studies the absorption lever by the different discrete volumes of canopy. We will obtain radiation and absorption maps at different levels.

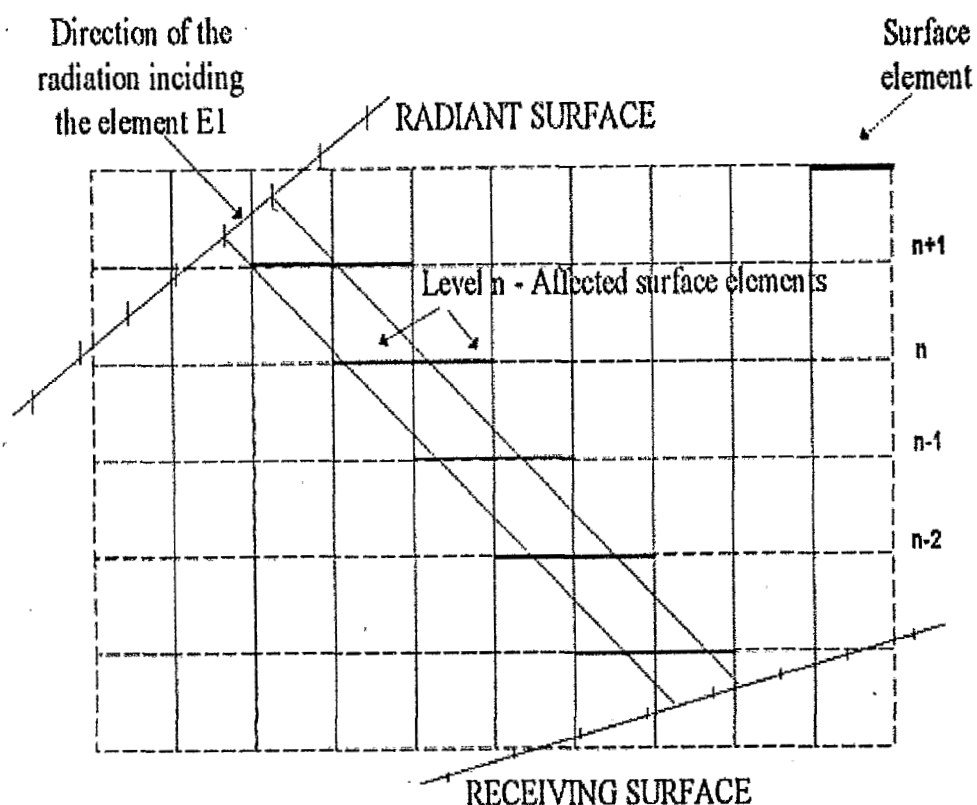

The tool uses finite-element techniques in two levels, greenhouse surfaces and volumes. In the calculation process the greenhouse structure is uncoupled, computing independently each of its surfaces, and the behavior of each issuing element of the surface is evaluated. It allows evaluating the radiation absorption in the different zones of the greenhouse.

The different transformations are executed by 'connective independent' modules. Each one is an independent and self-contained entity. Different modules communicate via 'message passing', with specialized request/serve subroutines. This information is given with standard formats, called Interchange Data Structures (IDSs). The different processes are divided in independent phases, managed by a special module (Handler). This one call different procedures (TSPS, Transformation Specific Processes), in an alternative and accumulative way. The overall agents' architecture on the modeller is:

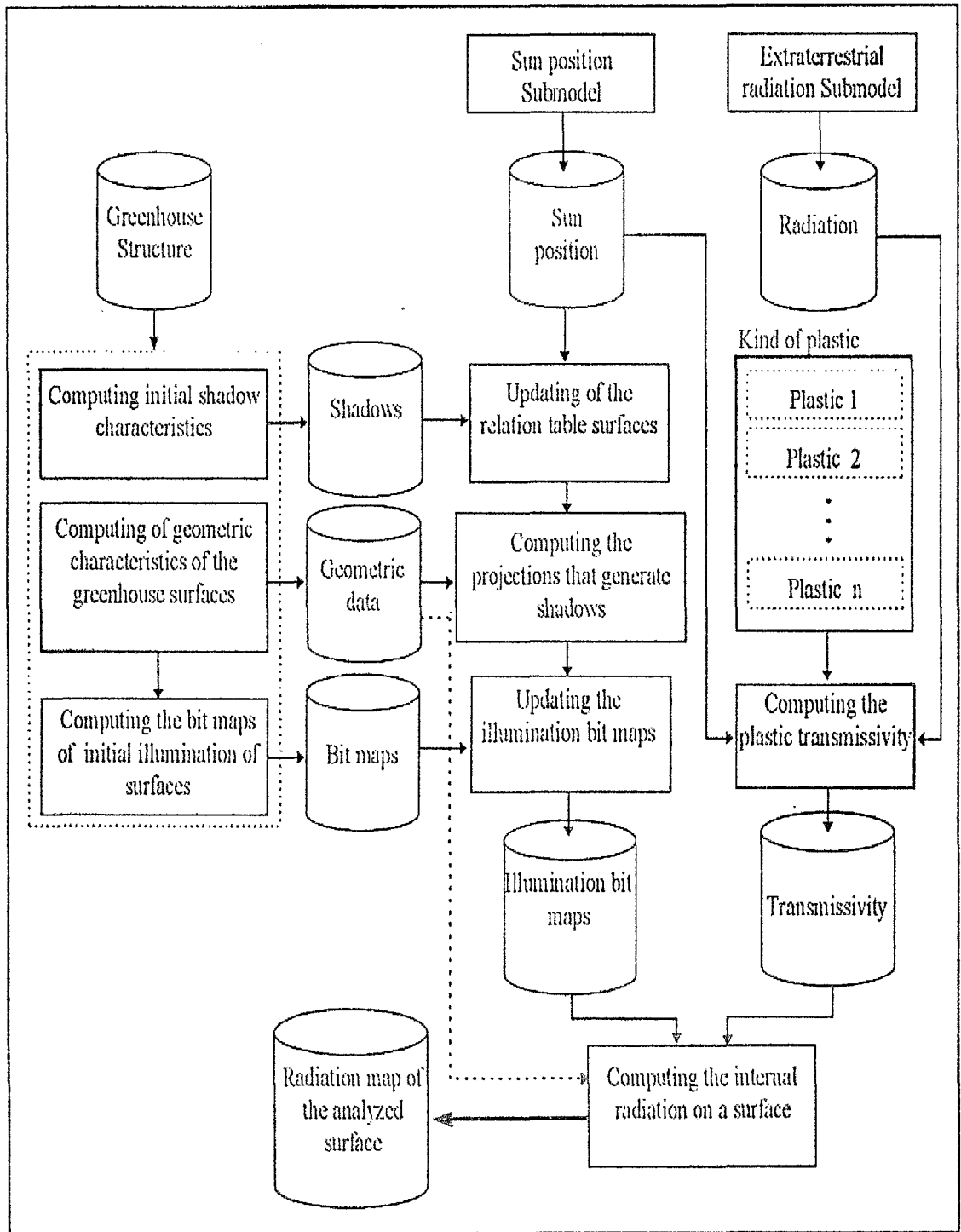

## RESULTS

### Greenhouse structures analyzed

We have built various greenhouse structures, the most standard type, other alternatives in expansion and other totally new ones. The basic new developments come from the Caja Rural de Almeria and the Universities of Cordoba and Polytechnic of Valencia. Furthermore, we built a first new prototype of greenhouse with variable roof. The structures and the principal characteristic of these greenhouses are showed in the next figures:

a) *Symmetric greenhouse.*

- Symmetric two slopes roof.
- Three North-South oriented naves.
- Dimensions: 22,5 x 26 m.
- Developed by the classic Almeria
- Greenhouse (parral).

b) *Asymmetric greenhouse.*

- Asymmetric two slopes roof.
- Two East-West oriented naves.
- Dimensions: 23 x 50 m.
- Developed from Caja Rural de Almeria

c) *Invernave greenhouse.*

- Symmetric two inverted catenary slopes roof.
- Three naves.
- Dimensions: 40 x 47 m.
- Metallic roofing laying on concrete pillar
- Developed by the University of Cordoba

d) *Parral or Almeria greenhouse.*

- Flat roof.
- Dimensions: 12 x 50 m

e) *Tunnel greenhouse.*

- Semicircular two slopes roof
- East-West oriented.
- Dimensions: 12 x 50 m.

b) *Variable roof greenhouse.*

- First prototype.
- Two slopes variable roof (changeable angles).
- Four East-West oriented naves.
- Objective: Experimental evaluation of different
- levels of asymmetry on the greenhouse roof

g) Using the previous studies and with the Polytechnic University of Valencia, which had developed a previous prototype, it has been assembled a new greenhouse that satisfies the proposed european standard "CEN/TC 284 GREENHOUSES". It agrees, also, the Spanish standards UNE 76 208-92 and NBE ea-95, and its principal characteristics are: two asymmetric curved slopes roof, three East-West oriented naves, dimensions: 25 x 50 m.



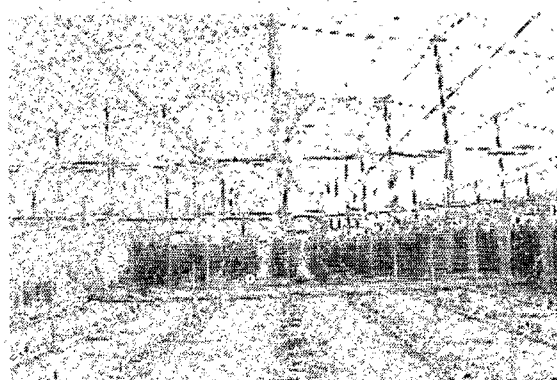
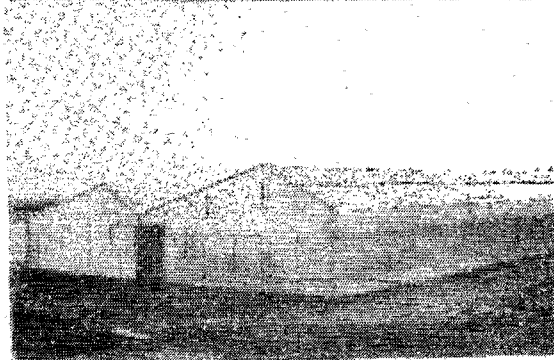
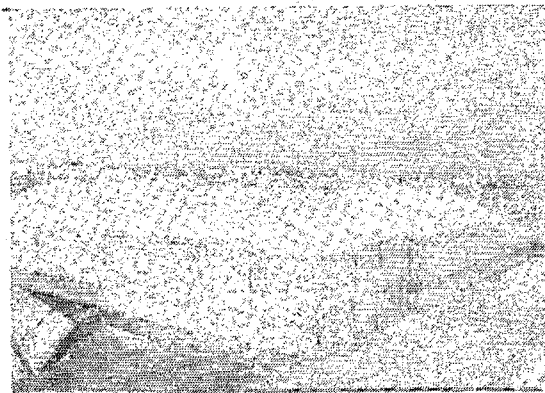

Top: Symmetric greenhouse (a).  
Centre: Asymmetric greenhouse (b).  
Bottom: Invernave greenhouse (c).



The obtained experimental data show that it holds clearly more radiation than the traditional marketed greenhouses, as we can see in the global radiation comparative. Also, there are less heat losses during the night, due to a better design and fit of their parts; preserving a longer time the inside temperature reached during the day. Better airing possibilities (folding, sliding and roll up windows) permit a first level of passive climatic control.

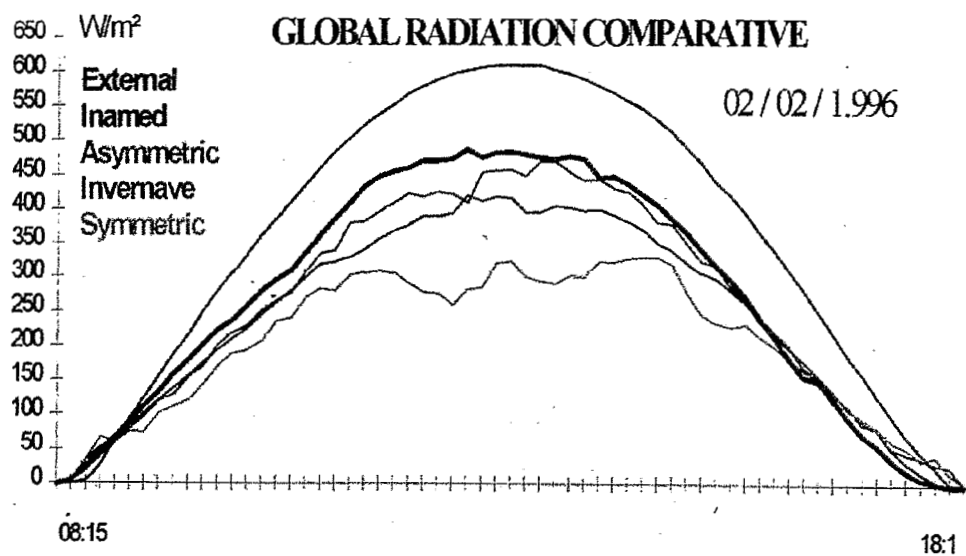

**Design tool**

With the design tool we can obtain different plans and budgets, as an example we show an extract of the plans generated automatically for an Invernave greenhouse case (we can see a three-dimensional view and three standard construction views):

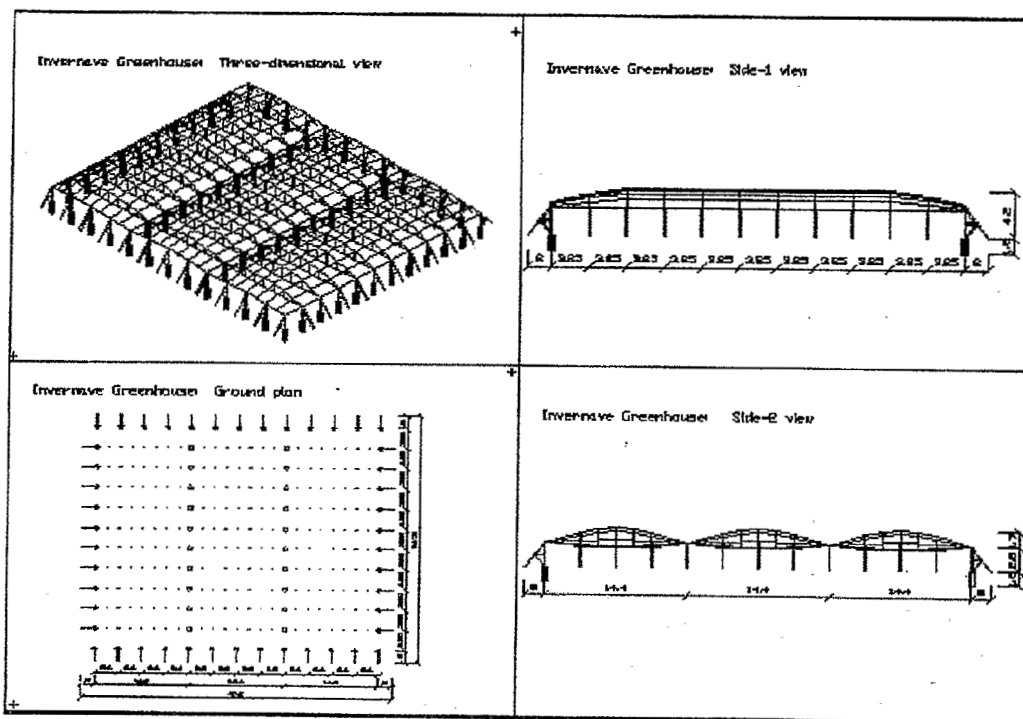

**Modellization tool**

The modellization tool permits to obtain maps of radiation inside the greenhouse, as an example we show the radiation on the floor surface of an empty asymmetric W-E oriented greenhouse. We have analyzed it, on June the 21st, at 13:09. At that moment, the position of the sun is -90' azimuth and 76.62' elevation. The results of the external radiation submodel are:

Global Radiation	Diffuse Radiation	Direct Radiation
1014..55 W/m <sup>2</sup>	166.59 W/m <sup>2</sup>	847.96 W/m <sup>2</sup>

The tool uses finite-elements 0.5 x 0.5 m sized (we can see two discretized surfaces).

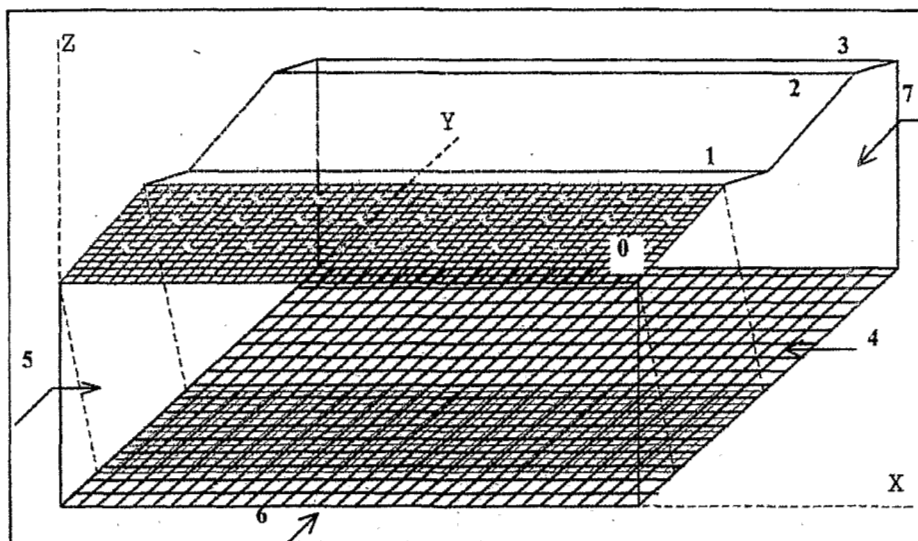

The shadow submodels classify the structure surfaces (0, 1, 2, 3 and 6 illuminated; 4, 5 and 7 no illuminated).

In the next step, the tool calculates the transmissivity of the illuminated surfaces. It uses the plastic submodel. Its inputs are the angles between the surfaces and the direction of the sunrays and the characteristics of the plastic (thickness 0.18 μm refraction coefficient 1.51, absorption coefficient 10)

The results of this submodel is a set of transmissivity coefficients

Surfaces	Transmissivity coefficient
0	0.9188986
1	0.9099238
2	0.9188995
3	0.9099238
6	0.5680429

Using these results, the tool uses the internal radiation submodel. It uses the radiation intensity on each surface and the direction of the refracted rays (precalculated).

This submodel generates a projection of the different external illuminated surfaces on the internal surface that we want to analyze. The final result is a map of the radiation in each finite-element of the analyzed surface:

189.51	189.51	189.51	189.51	189.51	189.51	189.51	189.51	189.51	189.51	189.51
189.51	189.51	189.51	189.51	189.51	189.51	189.51	189.51	189.51	189.51	189.51
189.51	189.51	189.51	189.51	189.51	189.51	189.51	189.51	189.51	189.51	189.51
189.51	189.51	189.51	189.51	189.51	189.51	189.51	189.51	189.51	189.51	189.51
189.51	189.51	189.51	189.51	189.51	189.51	189.51	189.51	189.51	189.51	189.51

That can be represented on a color radiation map:

Radiation Map (June 21st 13:09)

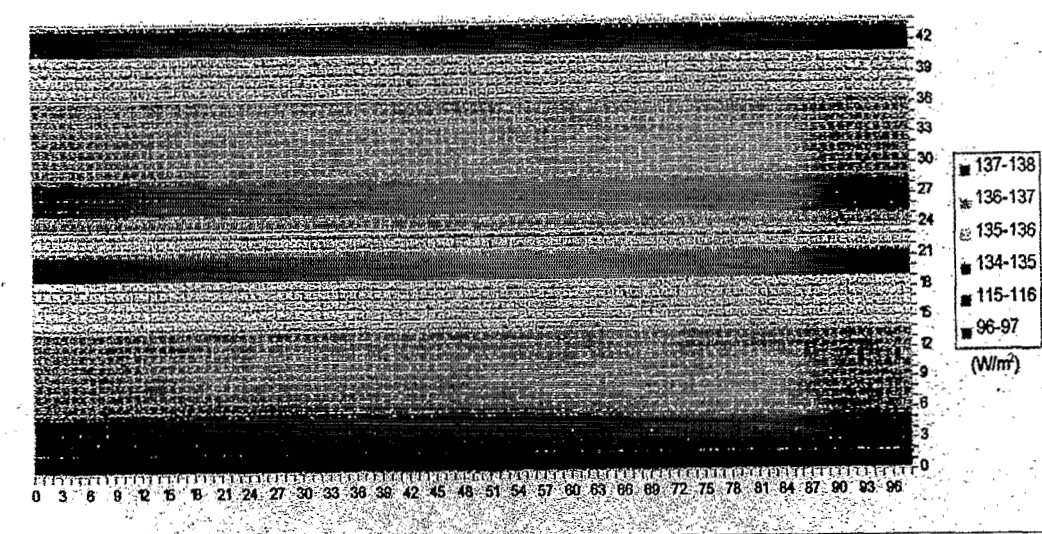

Subsequently it treats the illuminated surface elements like light emitters (after considering the processes of absorption, refraction and reflection), executing a set of cycles until the intensity level or the number of cycles cross respective limits. In this example, we have considered an empty greenhouse without canopy effect.

**Experimental analyses of the behavior of the greenhouses**

We have developed an exploration tool to analyze the experimental data obtained with the data acquisition and control tool that let us evaluates the results. The general diagram of this tool is represented in the next figure:

Daily, the tool validates all the readings of the sensors. It generates a set of direct results like:

- a.- Cumulative average radiation charts. b.- Evolution charts.
- c.- Conditional charts..
- d.- Tables and charts of daily data (classified by daily patterns).
- e.- Evolution charts.
- f - Temporal distribution of the values.
- g.- Space distribution of a variable into a greenhouse.
- h.- Maps of radiation and temperature along the day. Obtained by simulation using the experimental data

We can develop experimental models of radiation and temperature, because there is a high volume of stored microclimatic data (5 Gigabytes), getting us to verify the theoretical models. This module computes the evolution of the temperature or radiation on a horizontal greenhouse surface along a day.

## CONCLUSIONS

The objectives of the project have been acceptably reached, we can point these general conclusions:

- It is possible to develop new greenhouse structures offering better microclimatic conditions and control possibilities for our region.

The INAMED greenhouse is proposed as a specific solution in this way.

- It is possible to use new Information Technologies onto the process of design of these structures.

We have built a tool, DAMOCIA-Design, as general software for greenhouse projects development (7 typologies), that we will market in a short time.

- The use of new Information Technologies for simulating the behavior of the greenhouse seems viable for some microclimatic variables, and specifically for the radiation. (It is required a deeper analysis of the actual data).

We have implemented the tool DAMOCIA-Modeler that permits the simulation of the radiation into customized greenhouses in a general way of computing.

- It is of interest to dispose of an exploitation system to analyze experimental data in a general and flexible way.

We have assembled an acquisition and control system SIAC-FIAPA (it is used on simulations testing). Linked with this system there is a general microclimatic data exploitation tool, DAMOCIA-Explo.

Finally, we can point, briefly, the planned further developments:

- Exhaustive testing of the tool in other regions or countries.
- Increase the scope of design, adding new greenhouse typologies to DAMOCIA-Design.
- Extend the scope of simulation, including the modellization to others parameters (temperature, air flow, etc.), or adding new and more accurate mathematical submodels.
- Improve the computing performance, with better efficiency and speed. (Possibly distributing the processes on several machines or using IPC).
- Enhance the control system into the greenhouses, possibly via fuzzy control techniques and/or long term behavior patterns.

## REFERENCES

**Bienvenido, J.F. et al.; 1996.** "DAMOCIA: Computer-Aided Design for the Construction of Automated Greenhouses". AgEng'96.

**Bosch, A. et al.; 1991.** "Desarrollo de un sistema de diseño de estructuras de invernaderos". Cuadernos de divulgación. F.I.A.P.A.

**Bot, G.;** "Greenhouse Climate: From Physical Processes to a Dynamic Model". Wageningen, 1983.

**Critten, D.L.;** 1988. "Light Transmission through Structureless Multispan Greenhouses Roofs of Gothic Arch Cross Section". J. Agr. Eng. Res., 41, 319-325.

**Garcia, J.R. et al.;** 1995. "Declaraciones declarativas de distinto nivel: aplicación al diseño de invernaderos". Actas de las I Jornadas de Informática, 185-194.